

JHD-4/94.

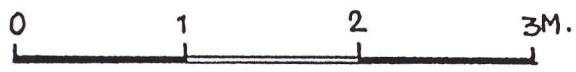

# AERONAUTICAL ENGINEERING SOCIETY

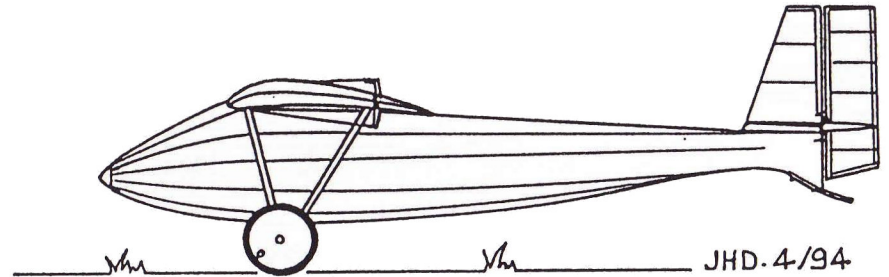
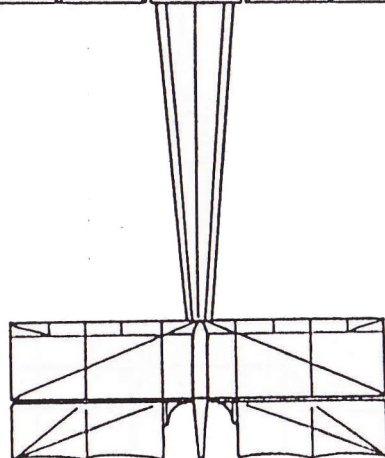
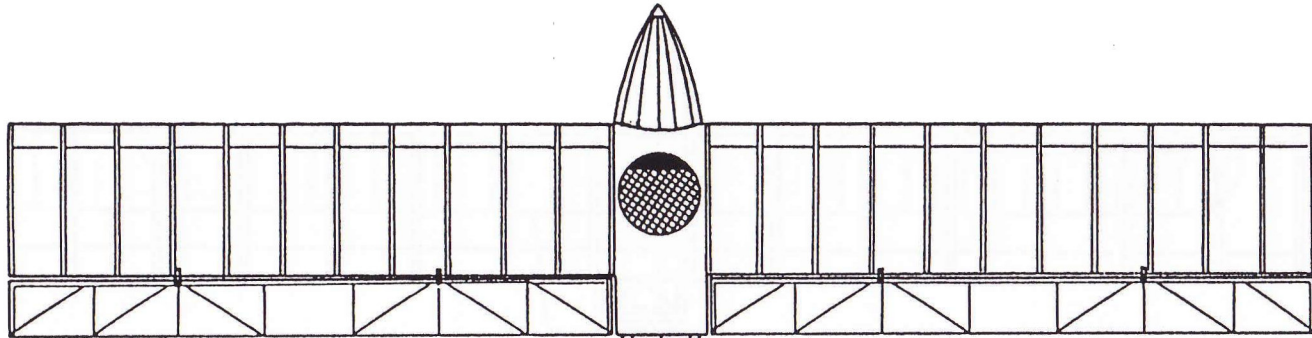
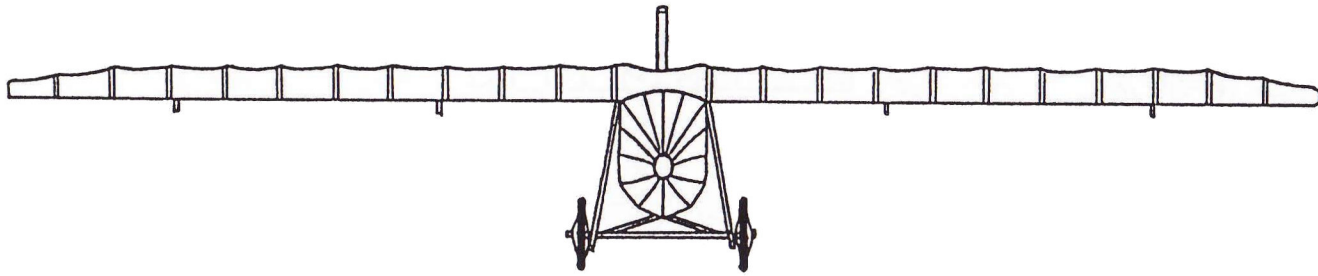

0 1 2 3M.

JHD. 4/94

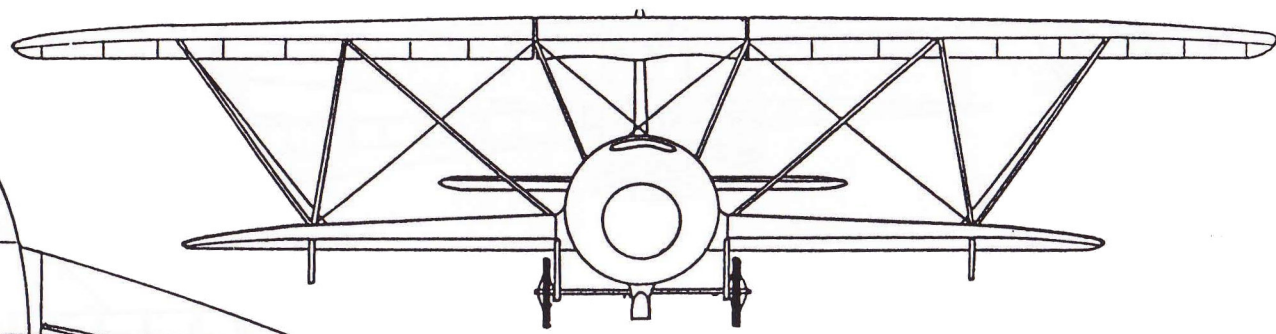
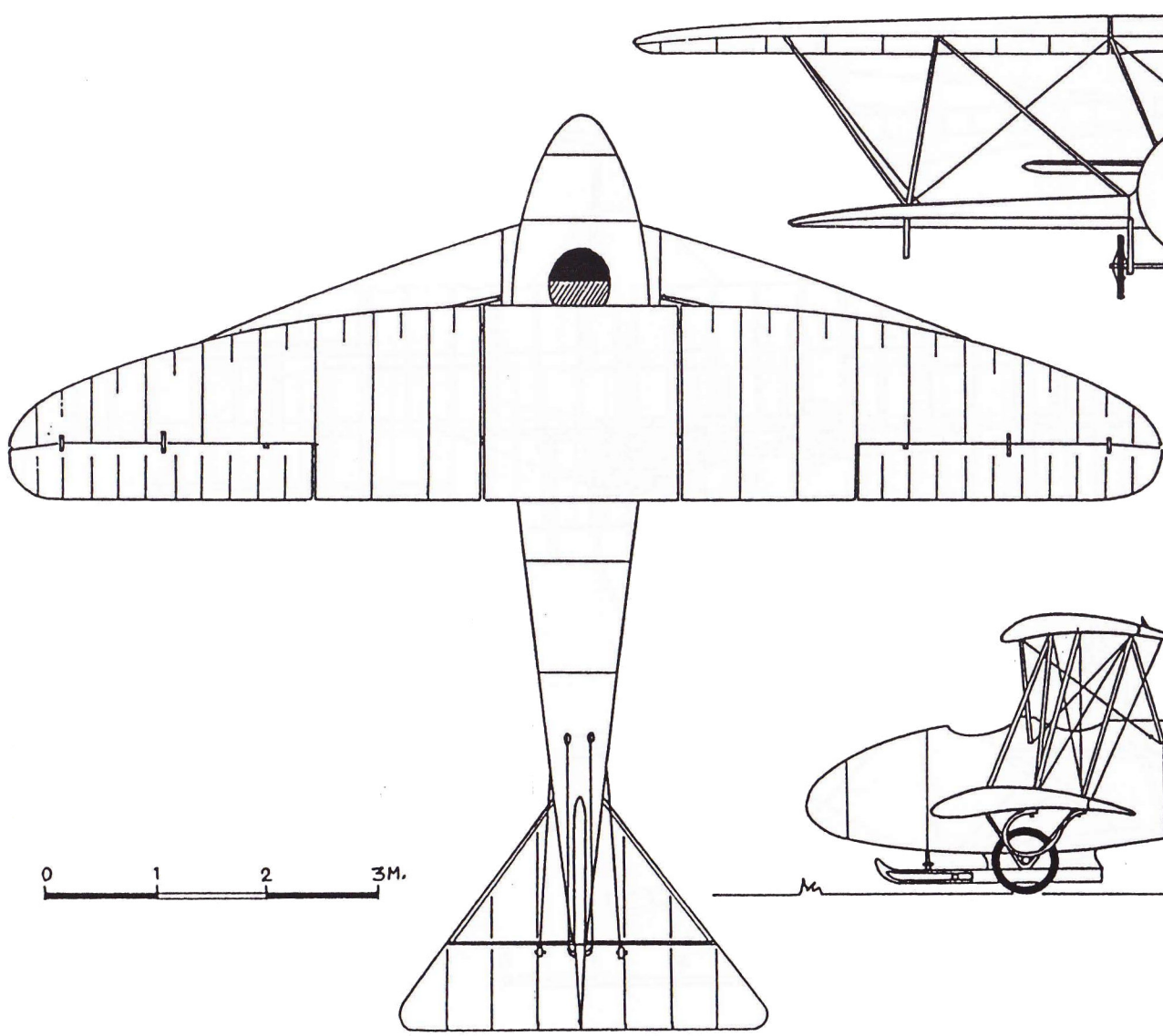

**BELLANGER-DENHAUT**

0 1 2 3M.

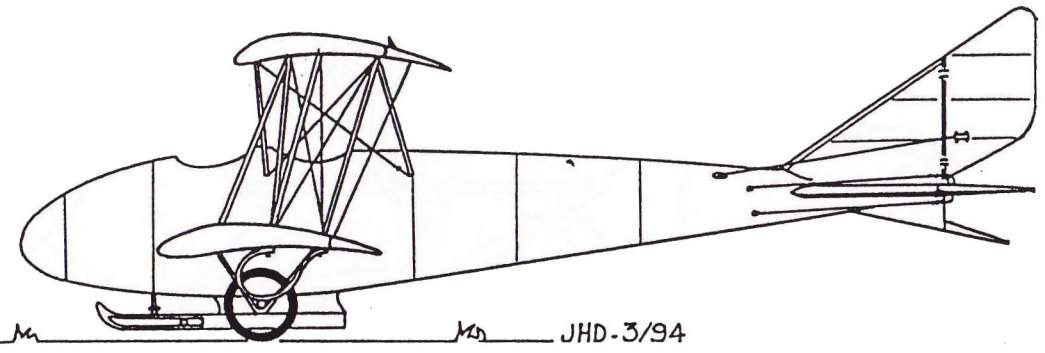

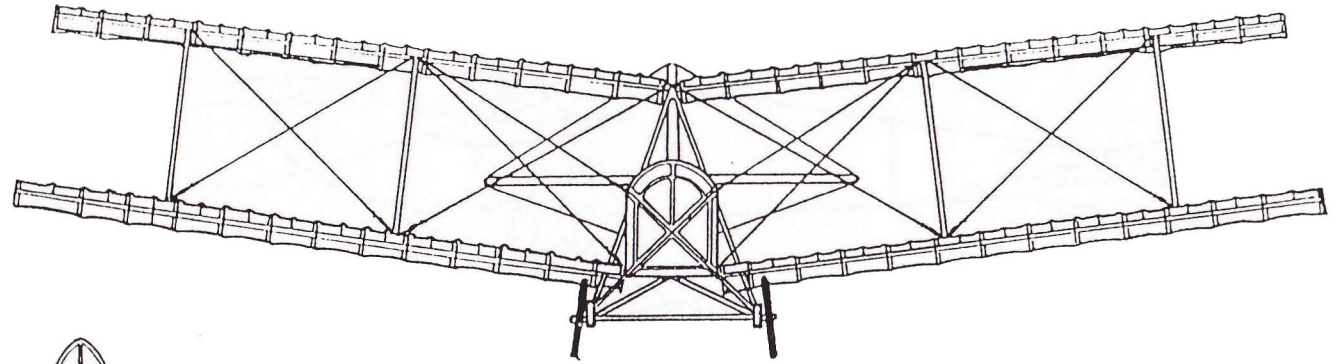

BONNET-CLEMENT

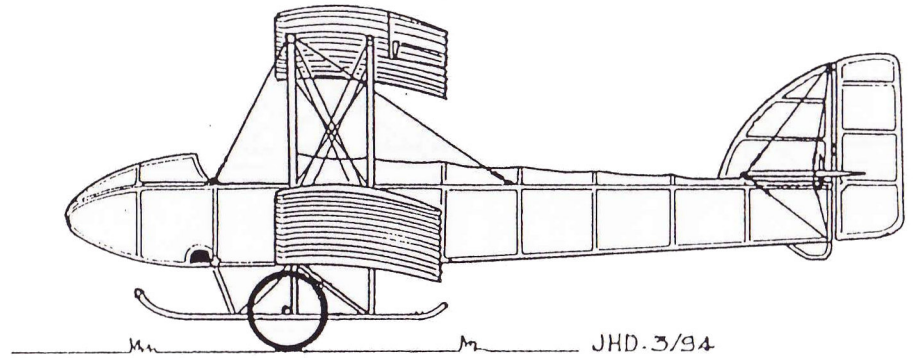
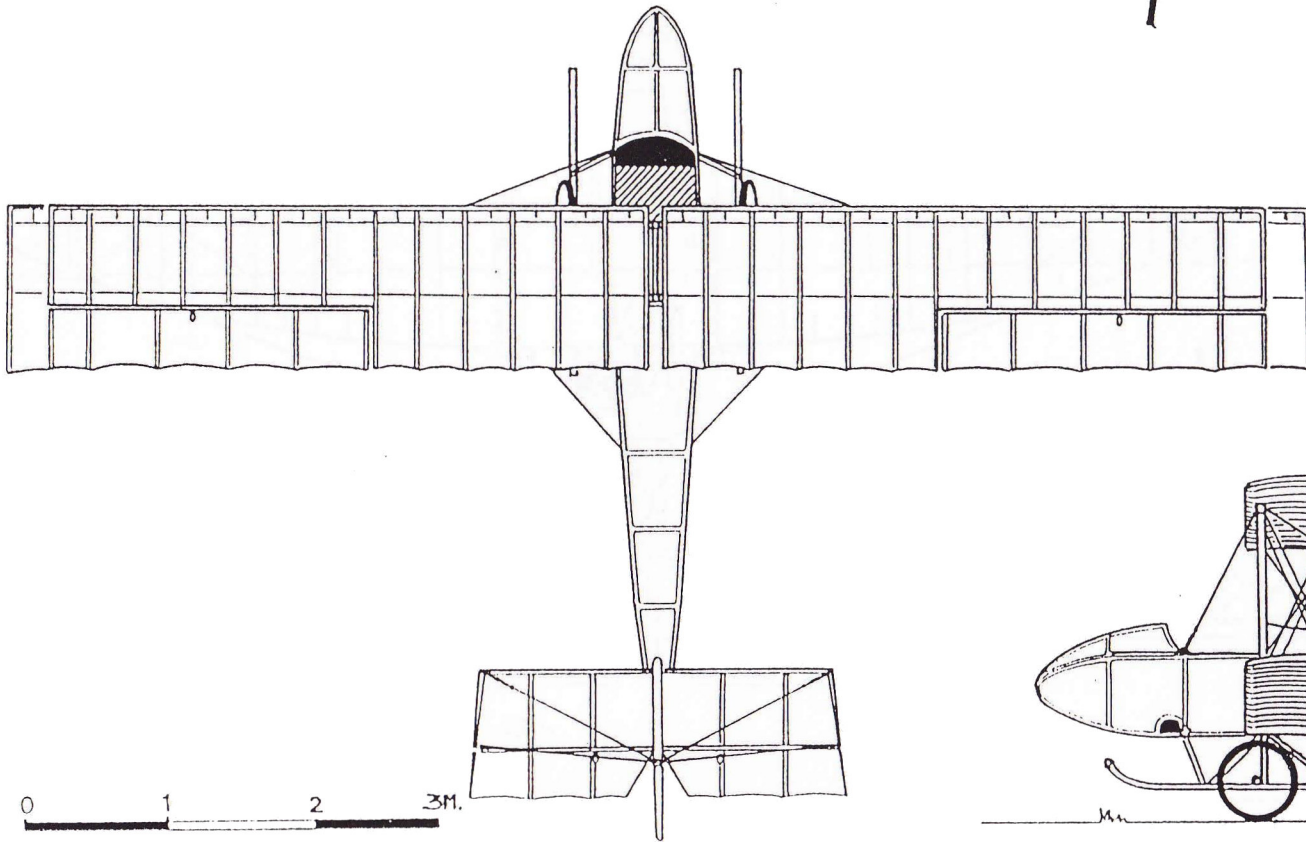

0 1 2 3M.

M. JHD. 3/94



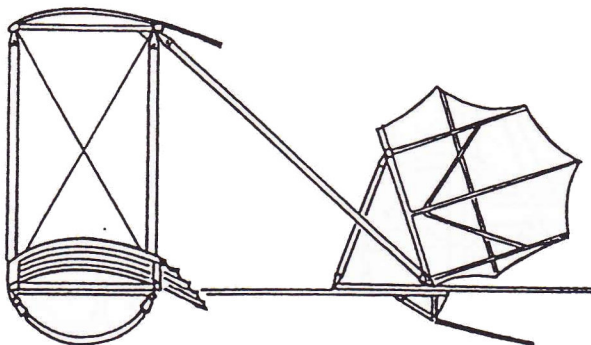
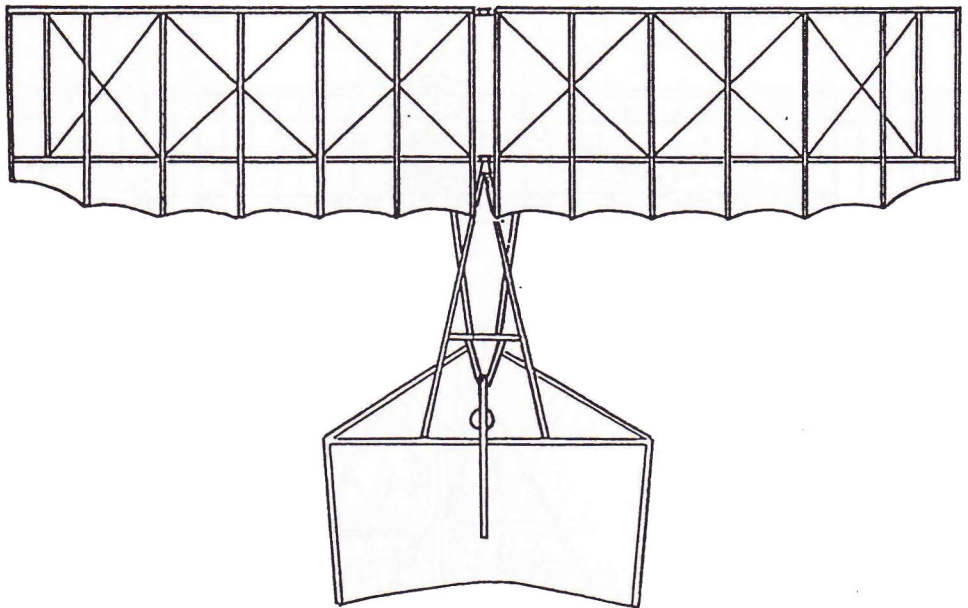
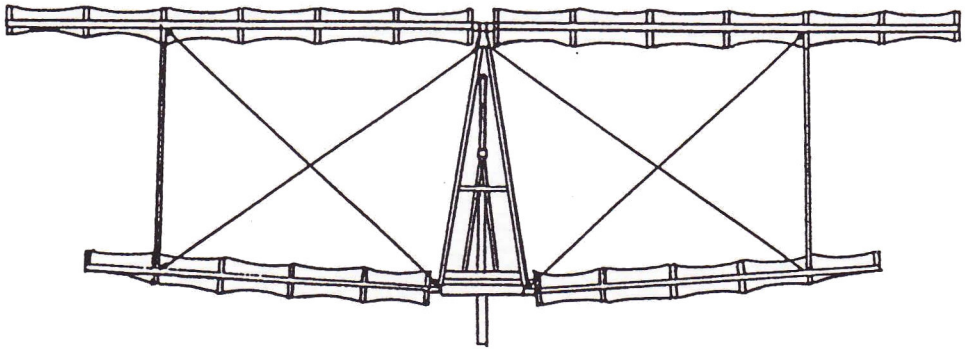

# COUPET-GUERCHAIS

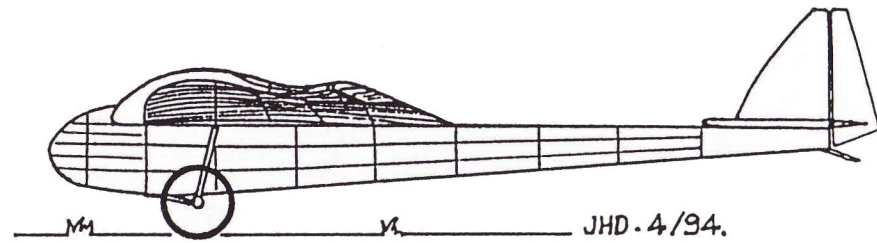
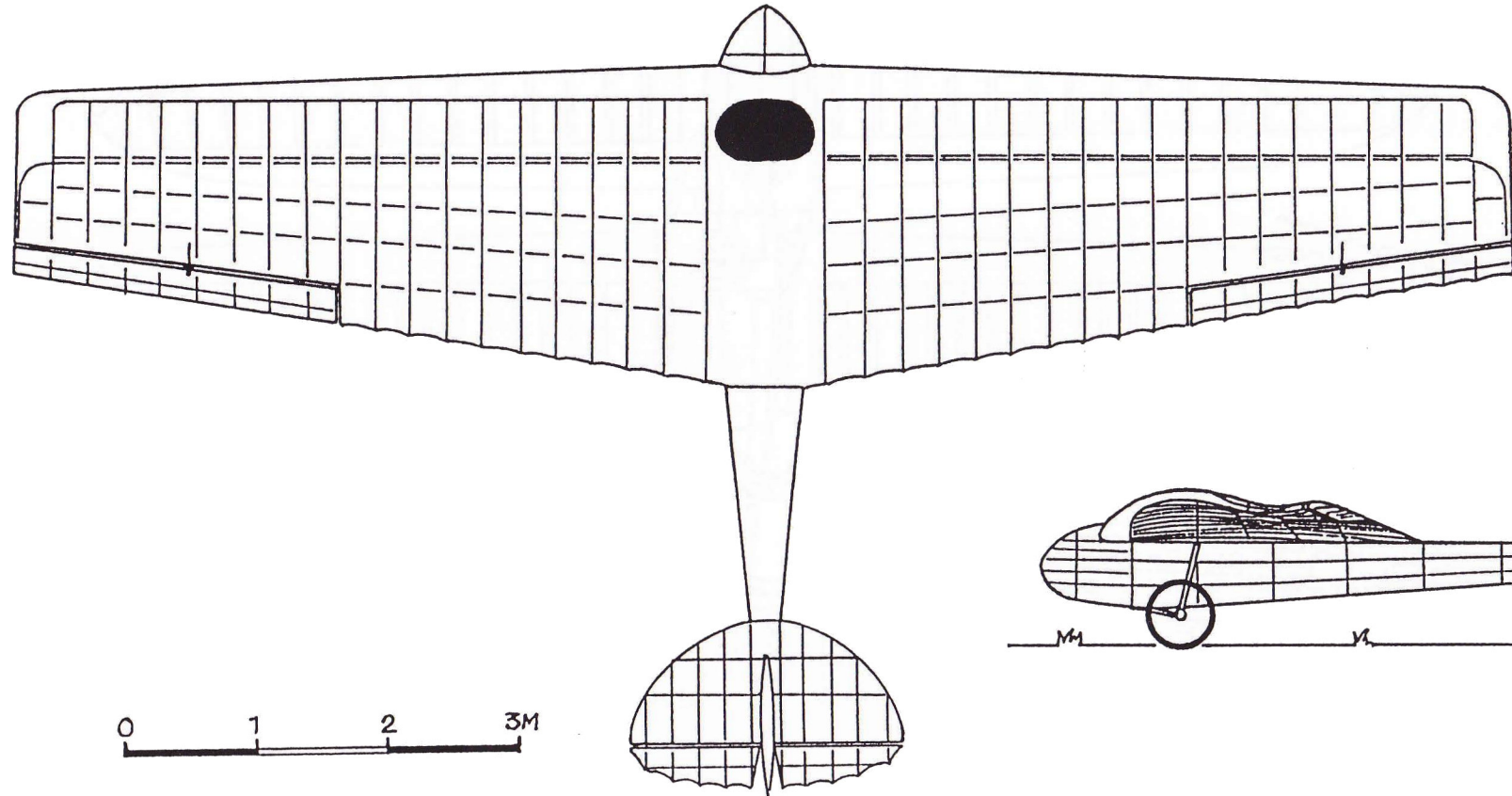
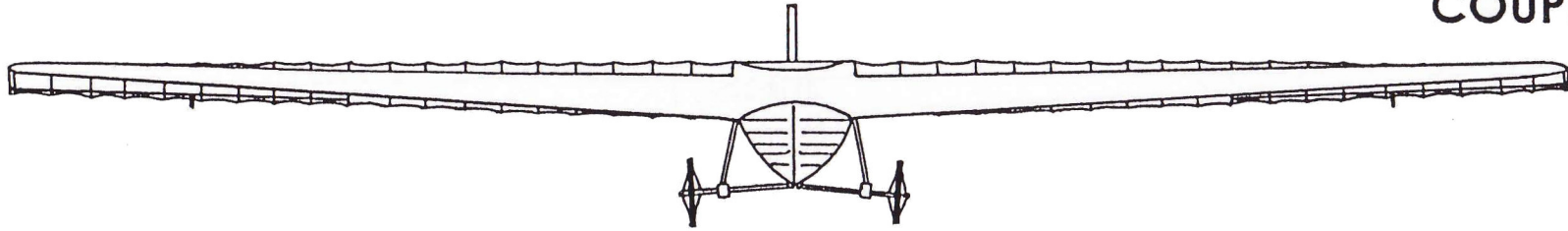

0 1 2 3M

JHD - 4/94.

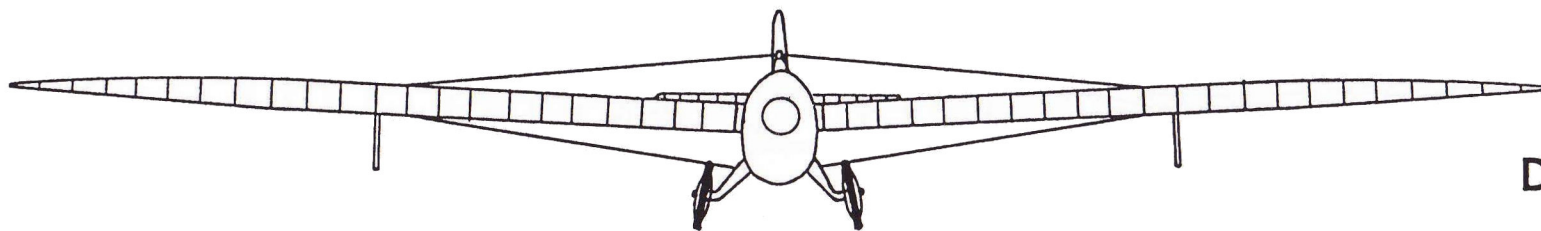

DESHAYES

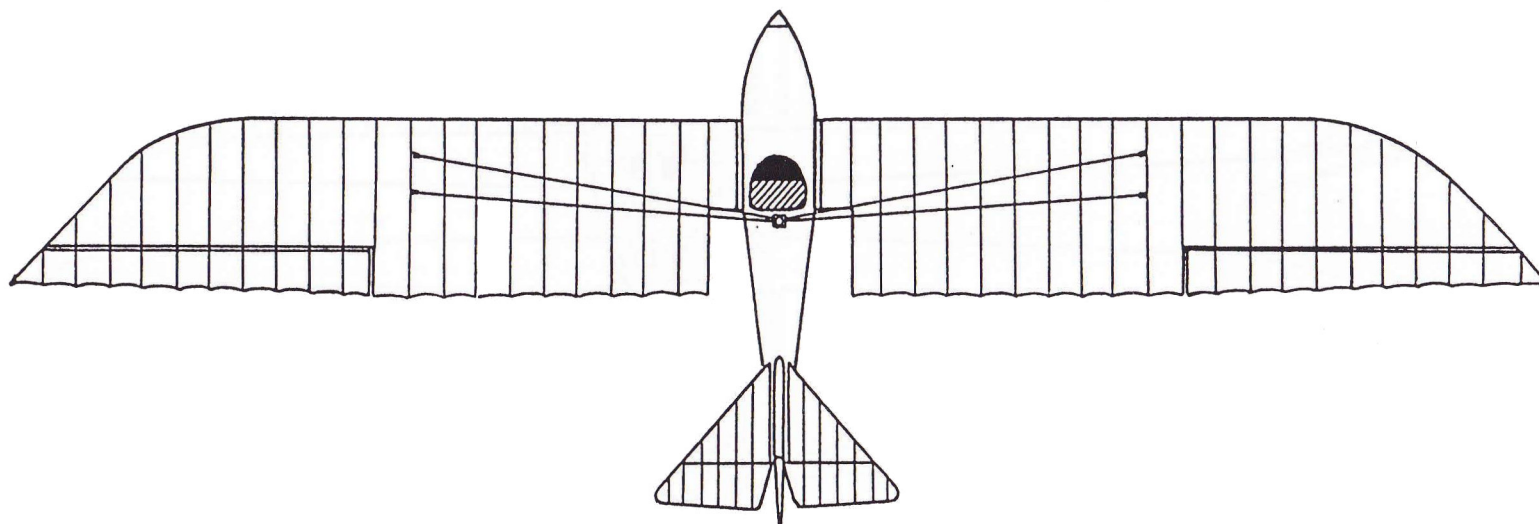

0 1 2 3 M.

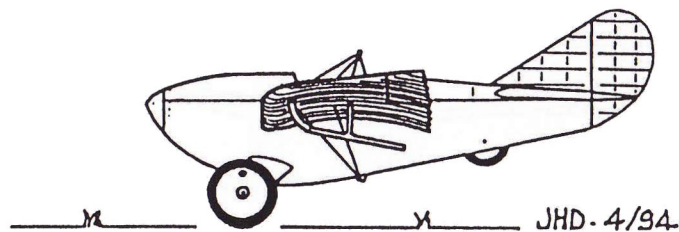

JHD-4/94

# DEWOITINE P-1

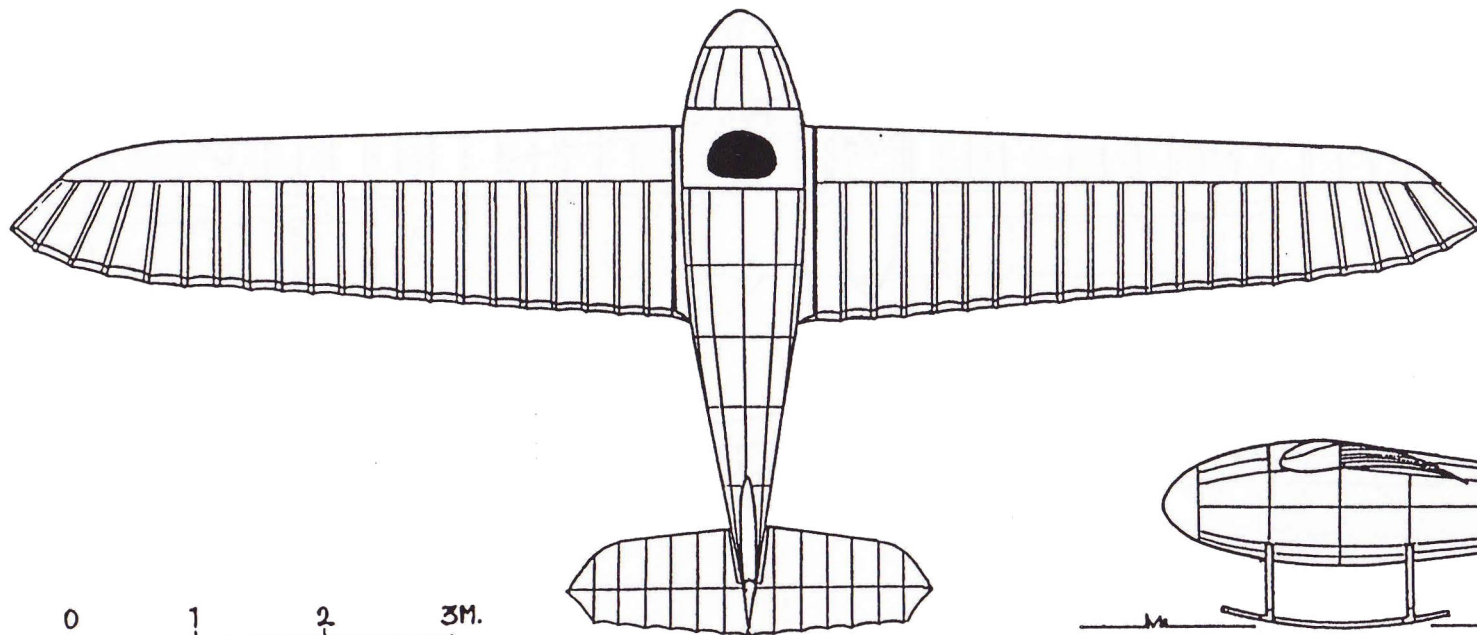
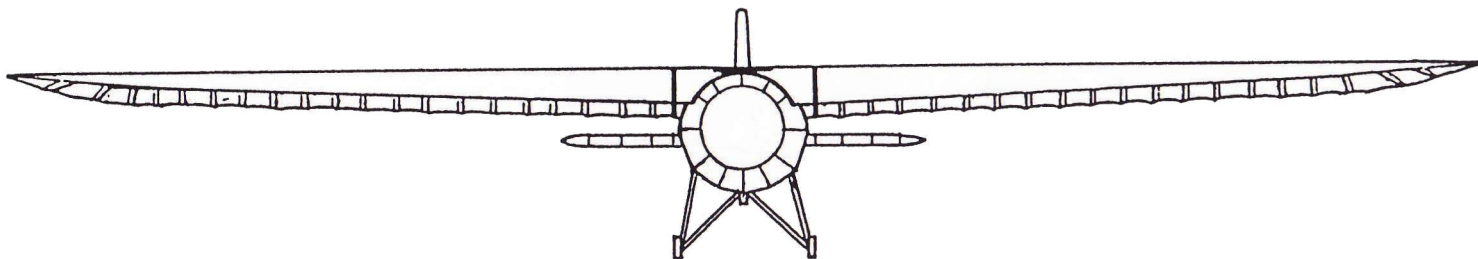

0 1 2 3M.

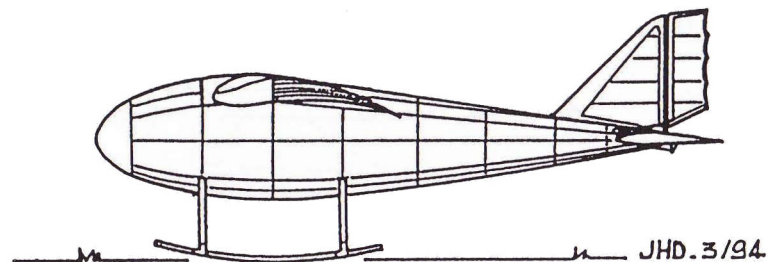

JHD. 3/94.



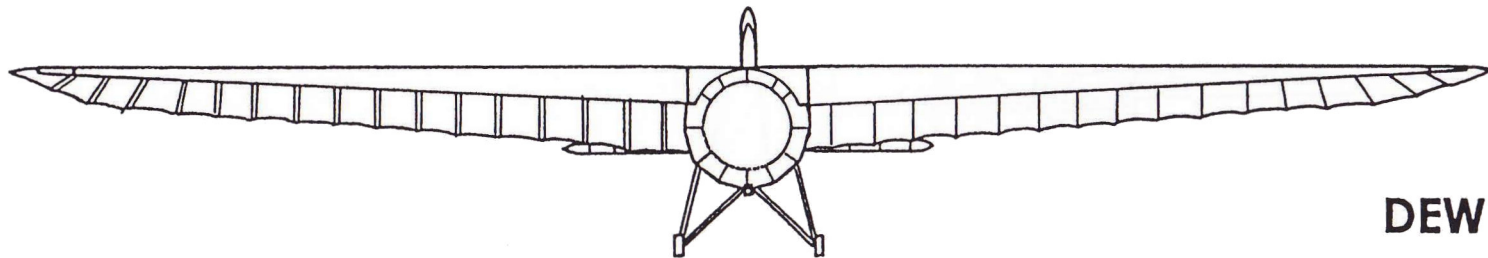

DEWOITINE P-2

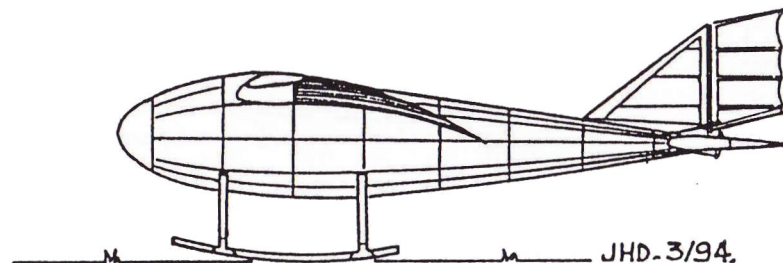
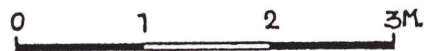
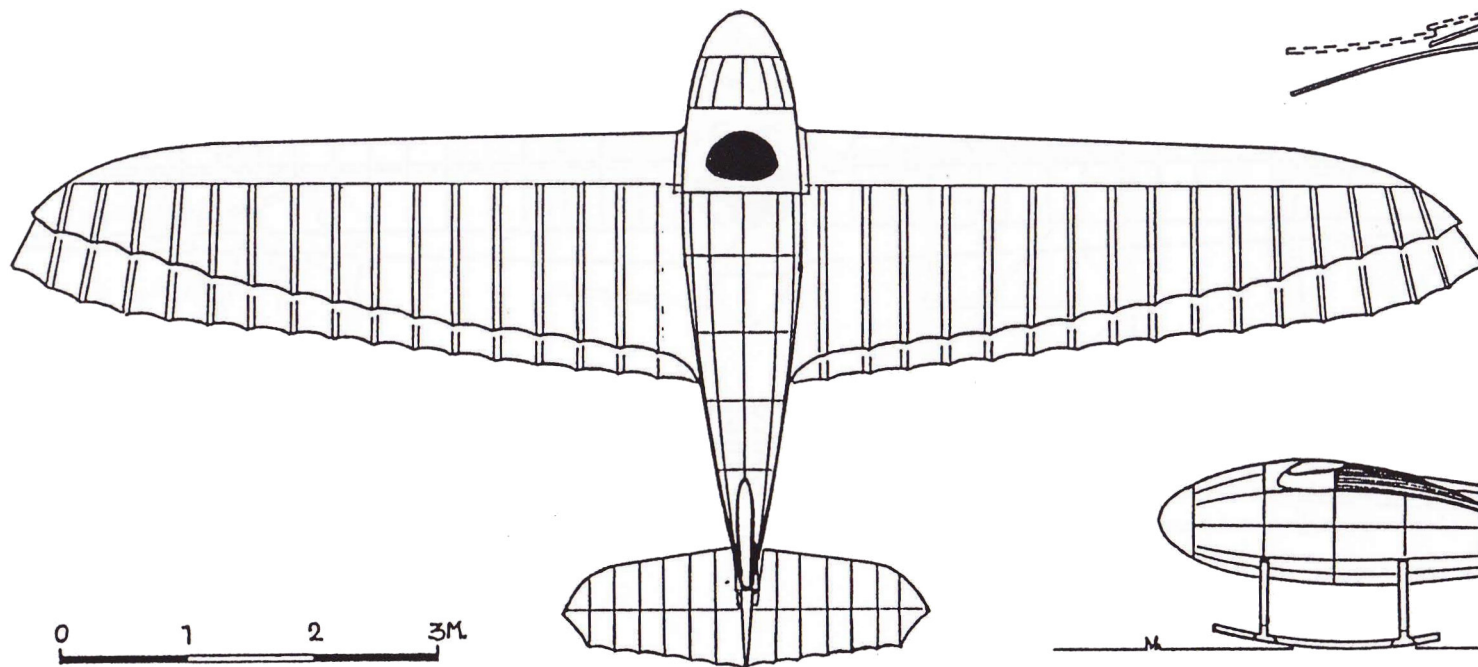

JHD-3/94.

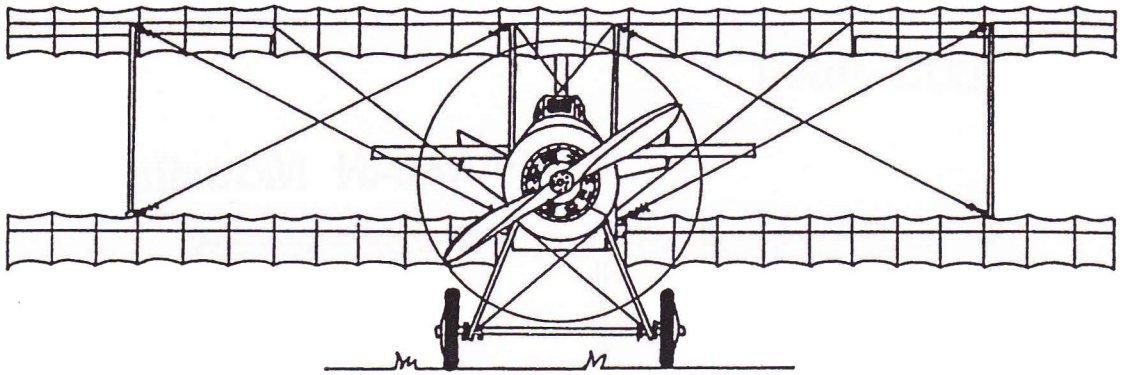

FARMAN David

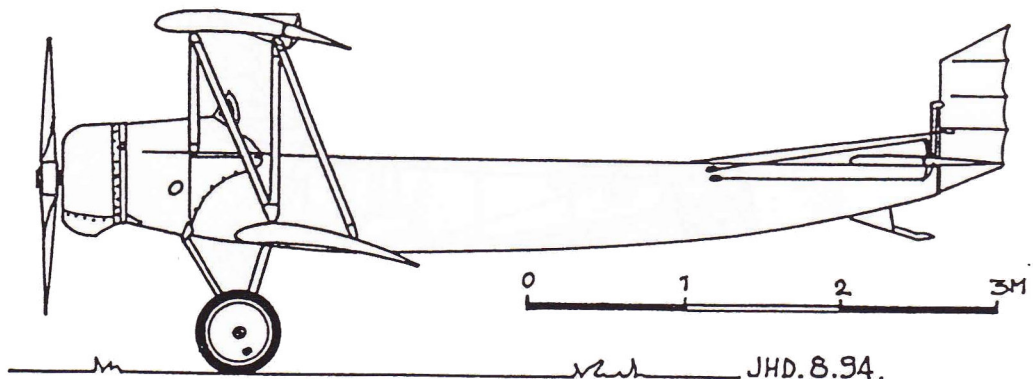
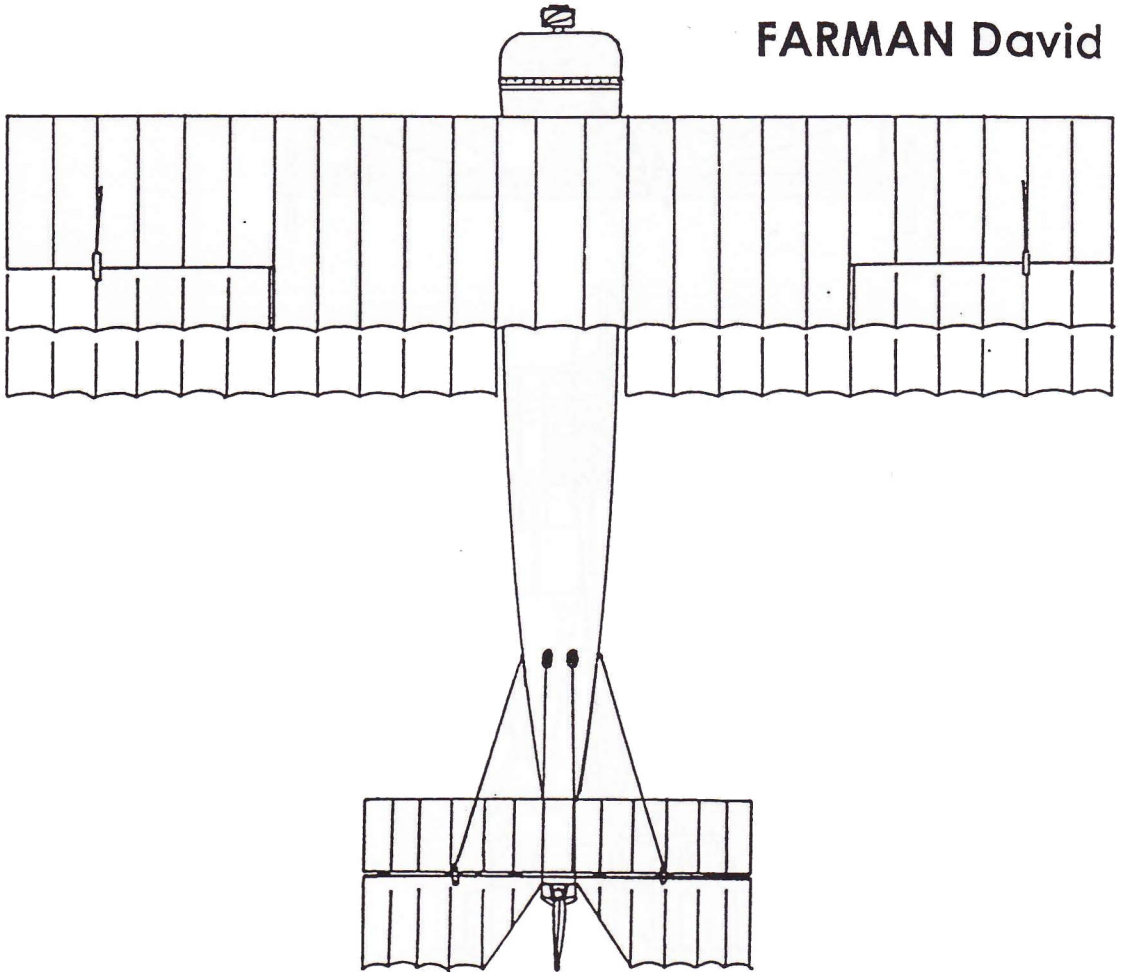

# FARMAN Moustique

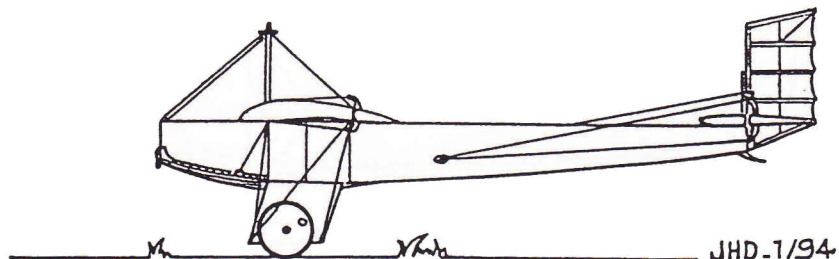
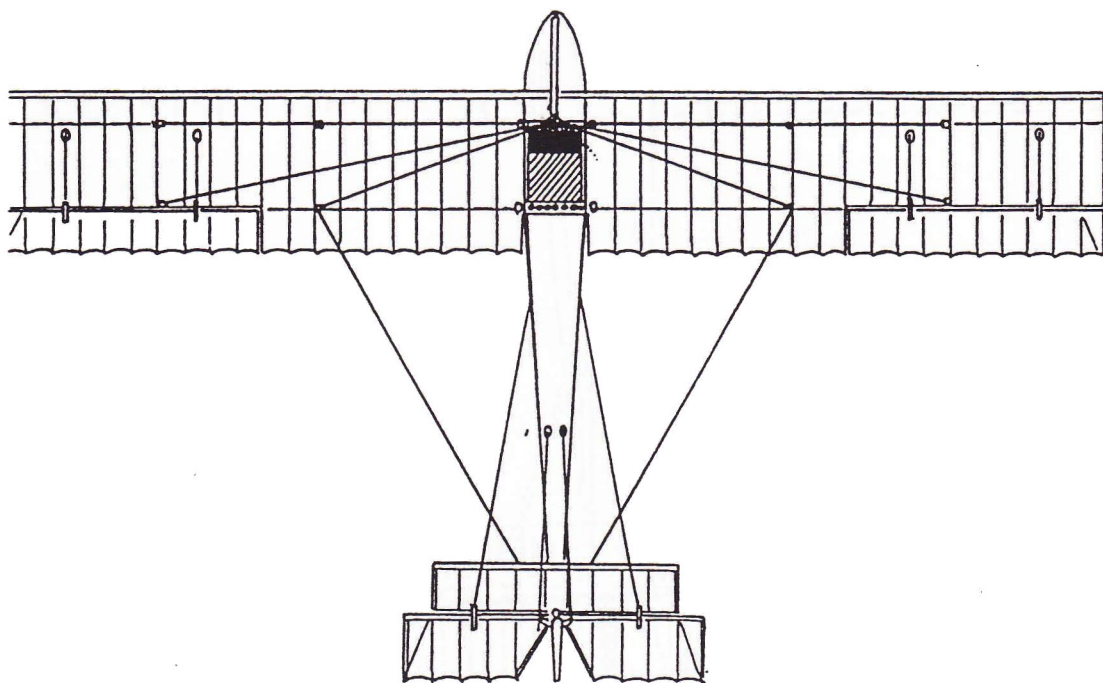
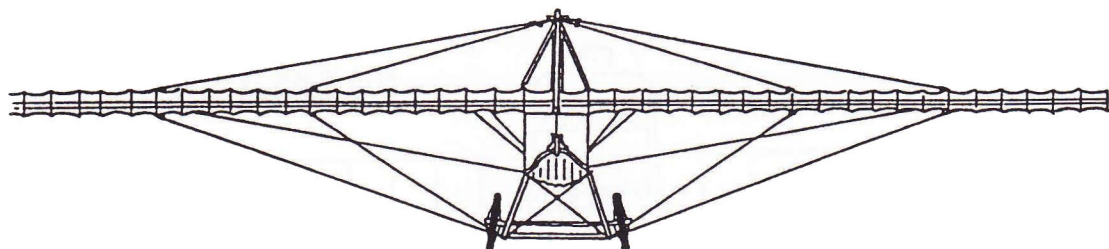

1 2 3 4M

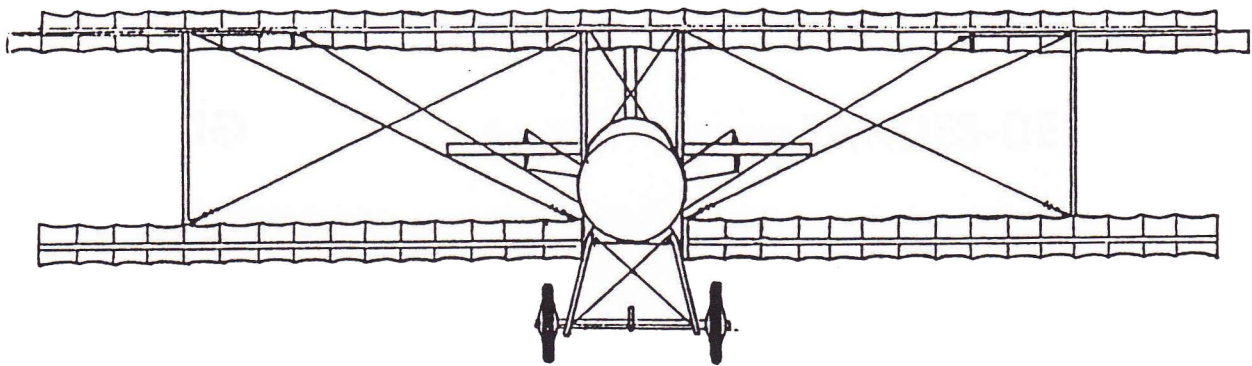

FARMAN Sport

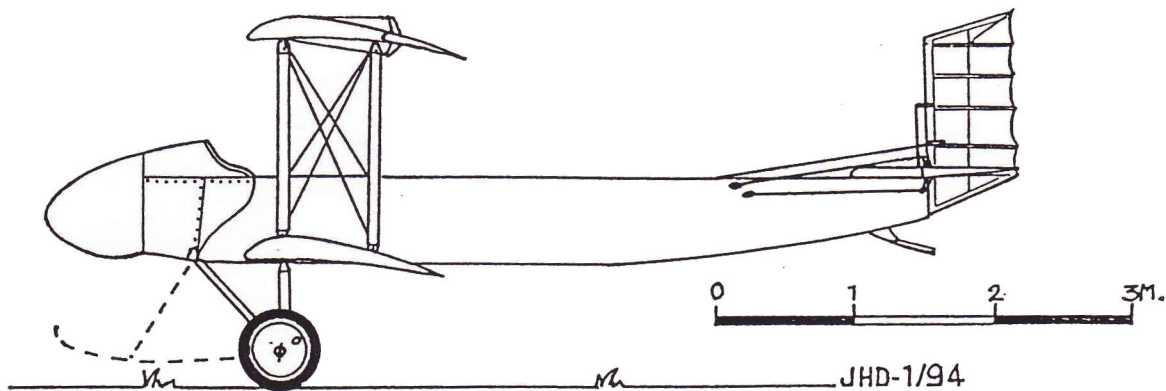
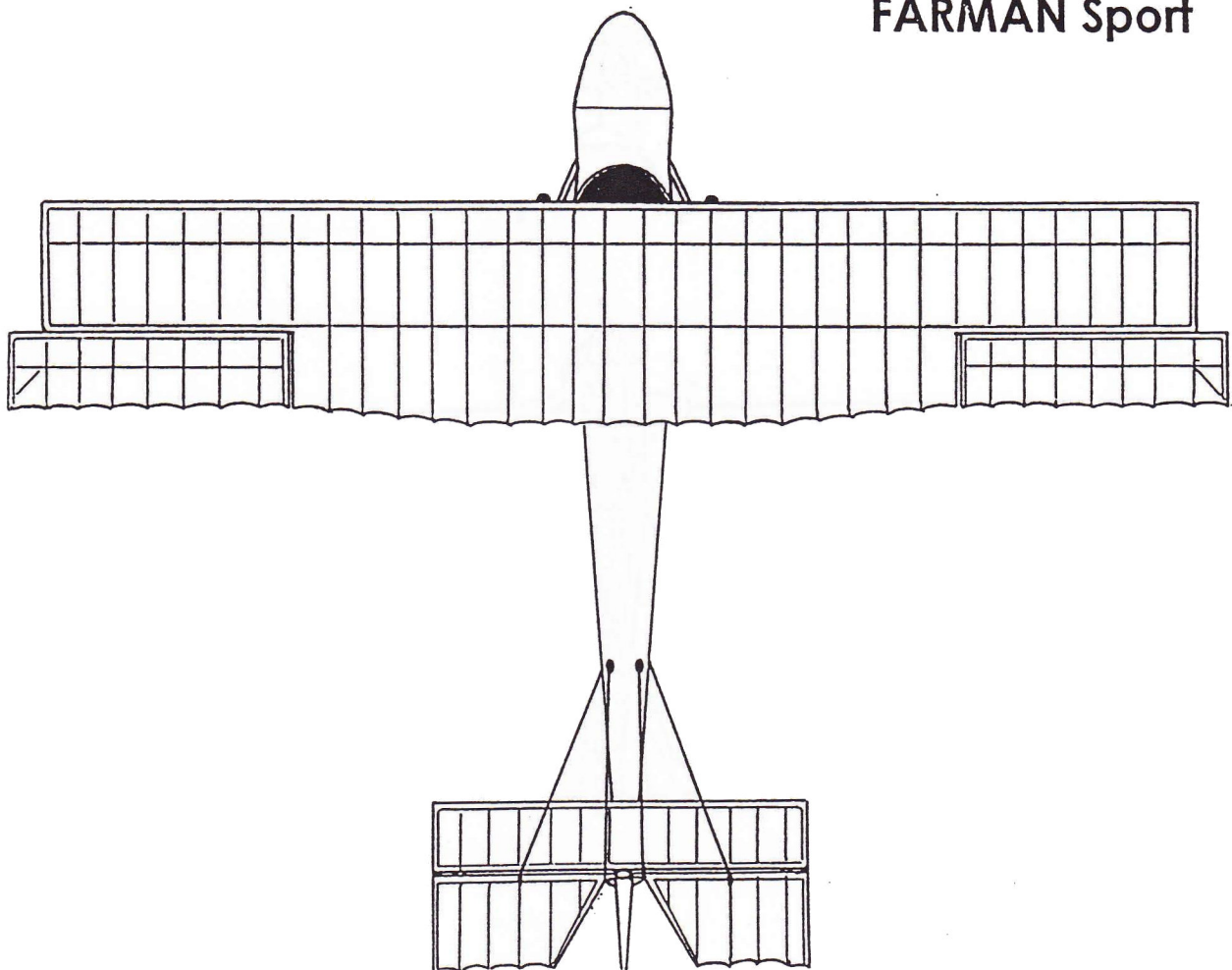



Georges-SABLIER

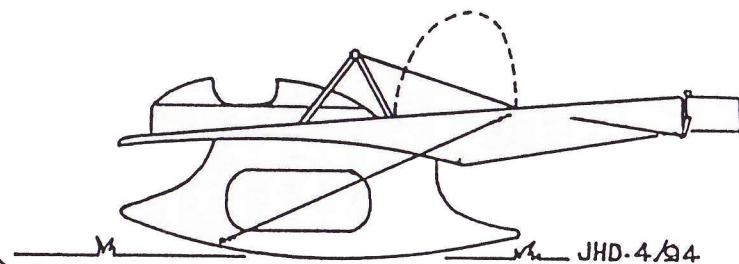
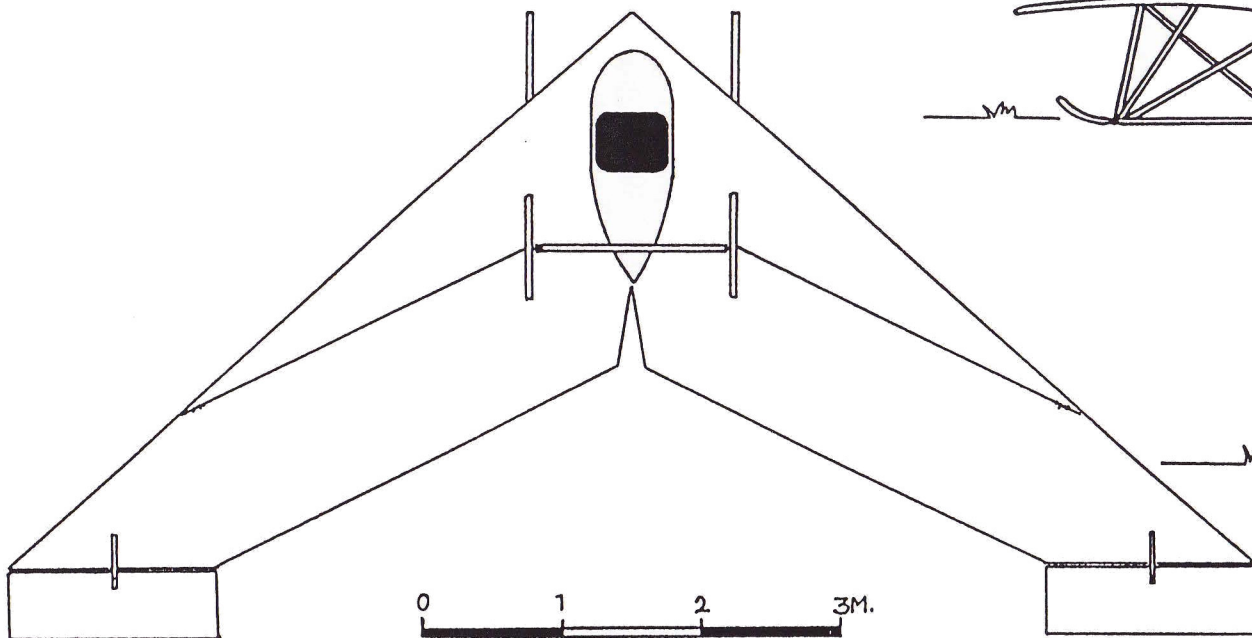
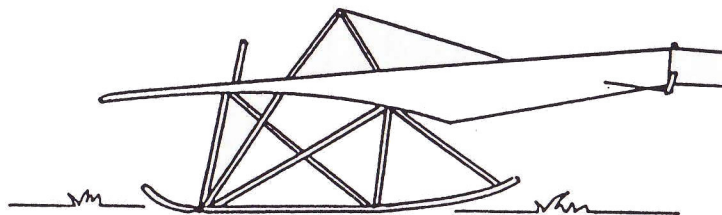
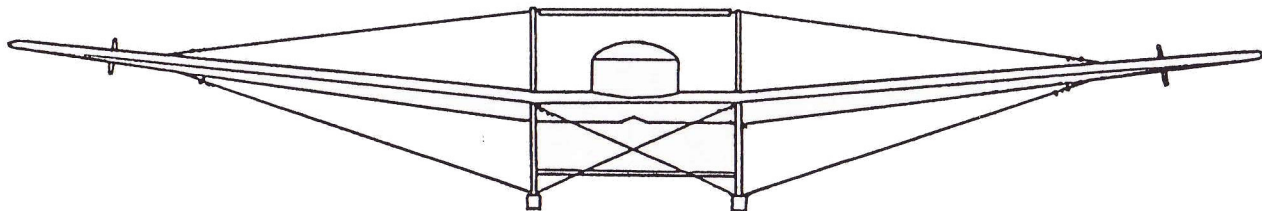

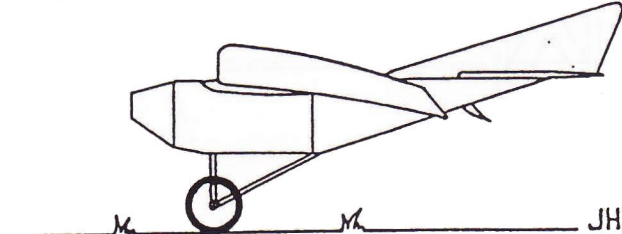
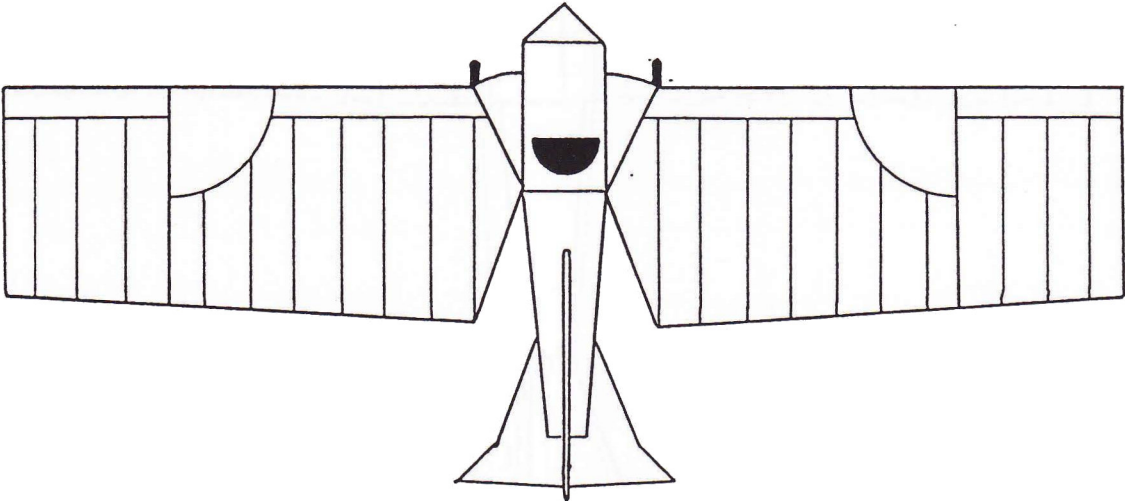
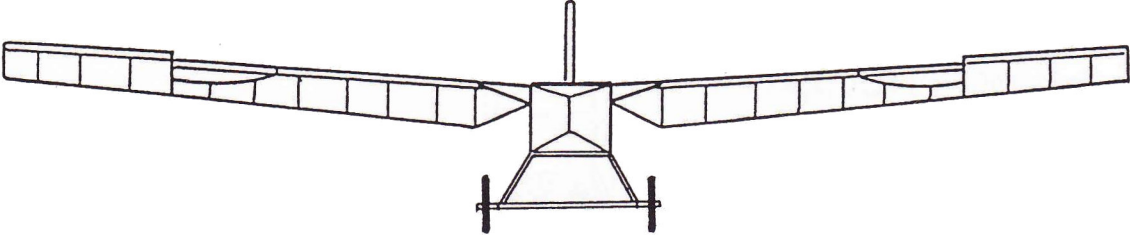

# LANDES-DEROUIN

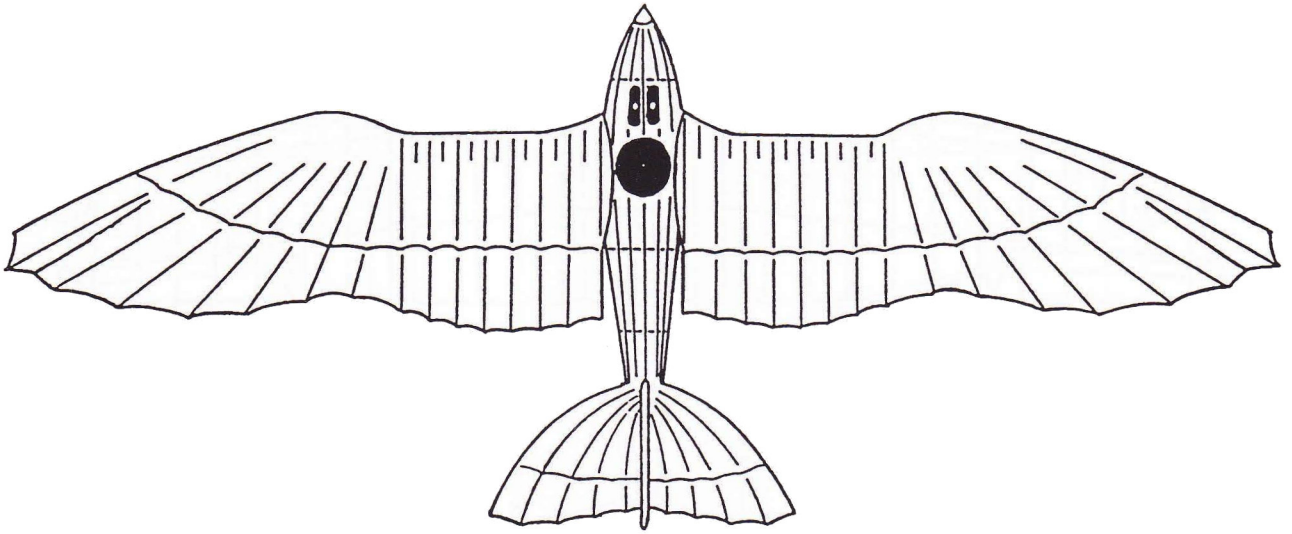
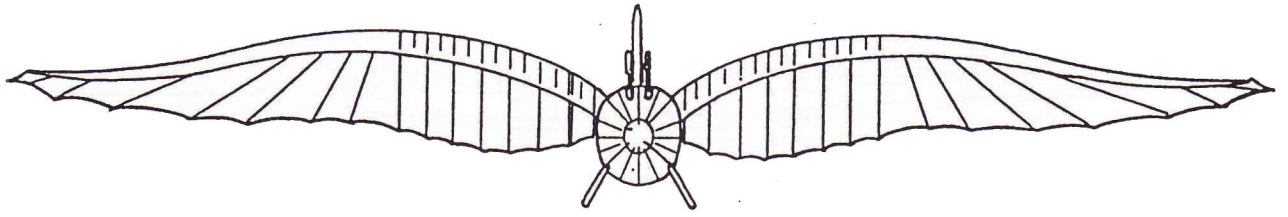

0 1 2 3M.

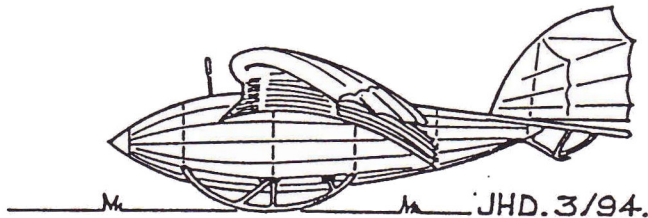

# LEVASSEUR-ABRIAL

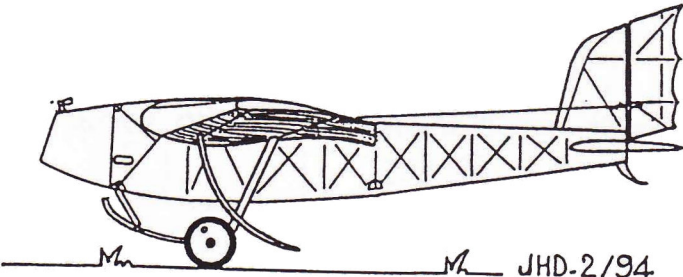
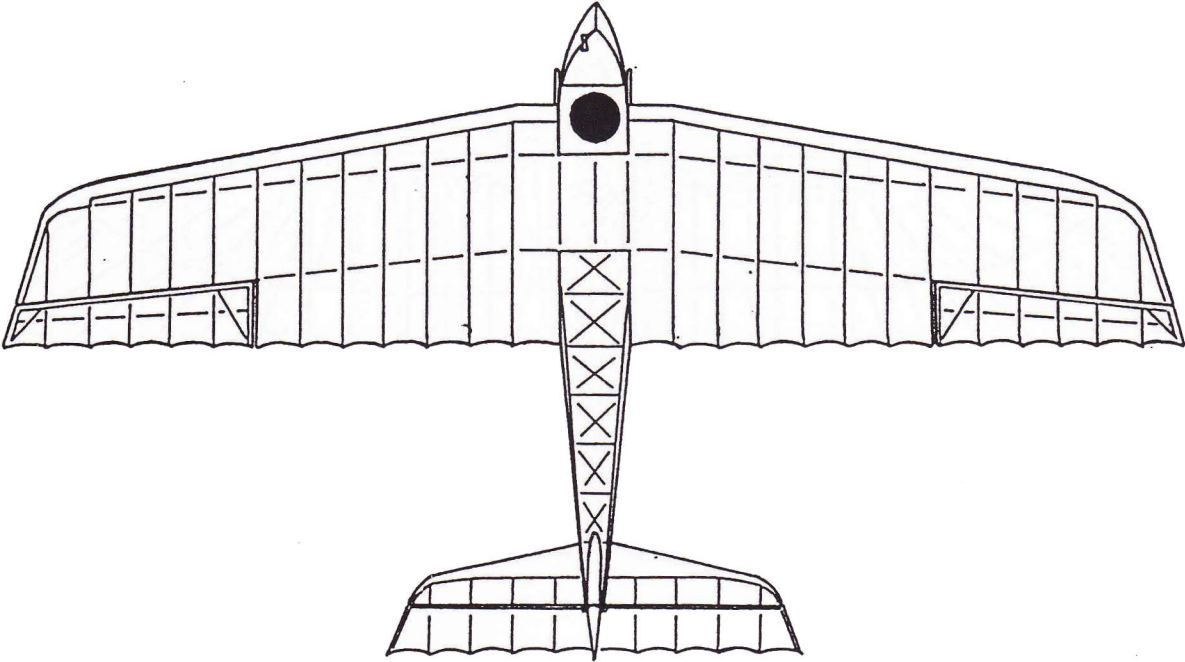
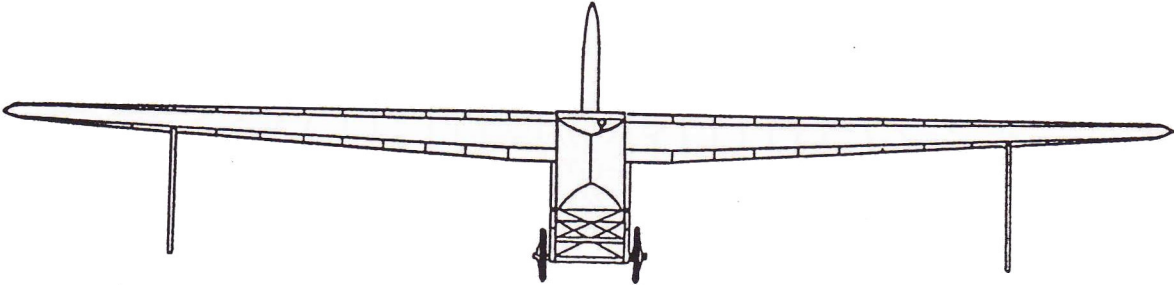

M

M

JHD-2/94



# Louis-CLEMENT

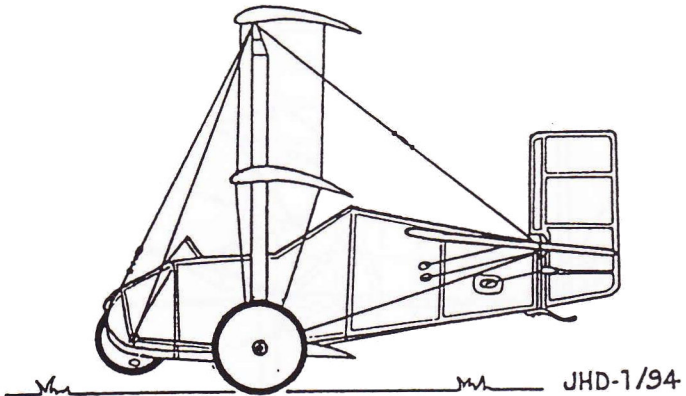
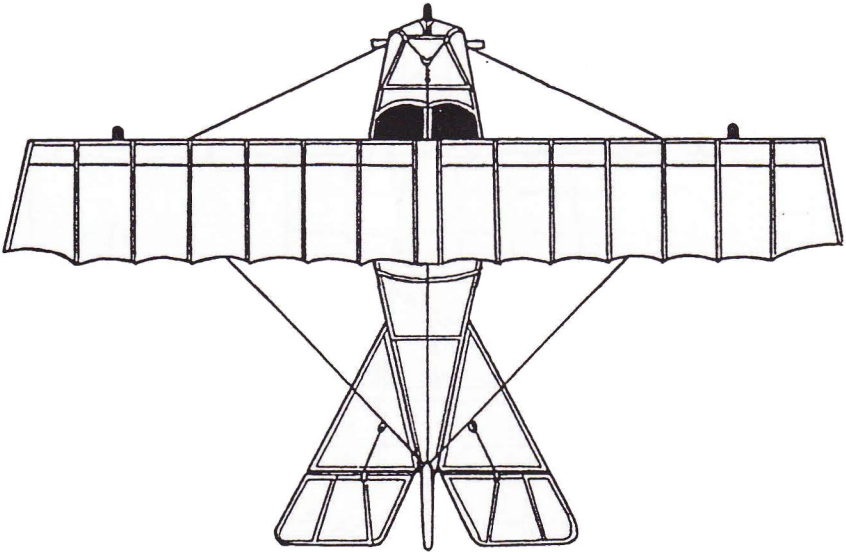
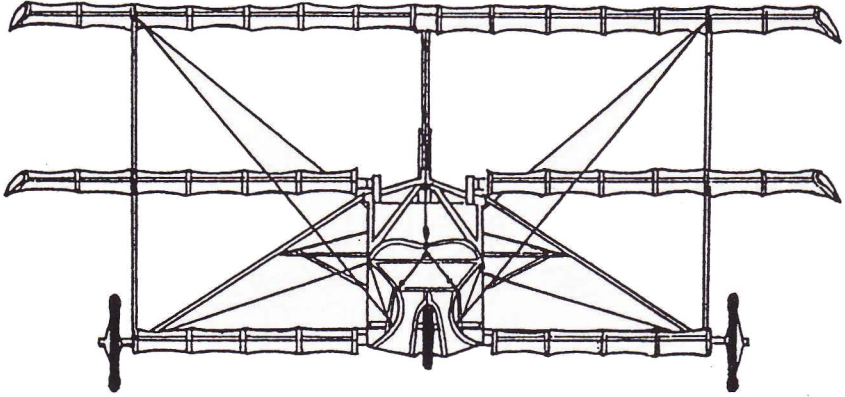

JHD-1/94

Louis-DE MONGE

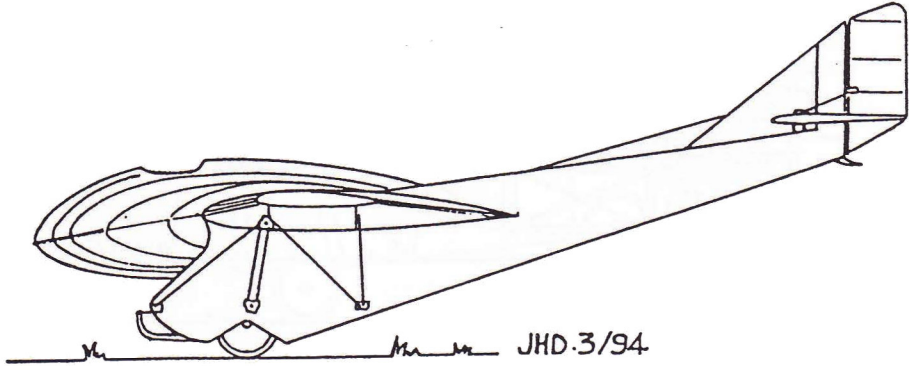
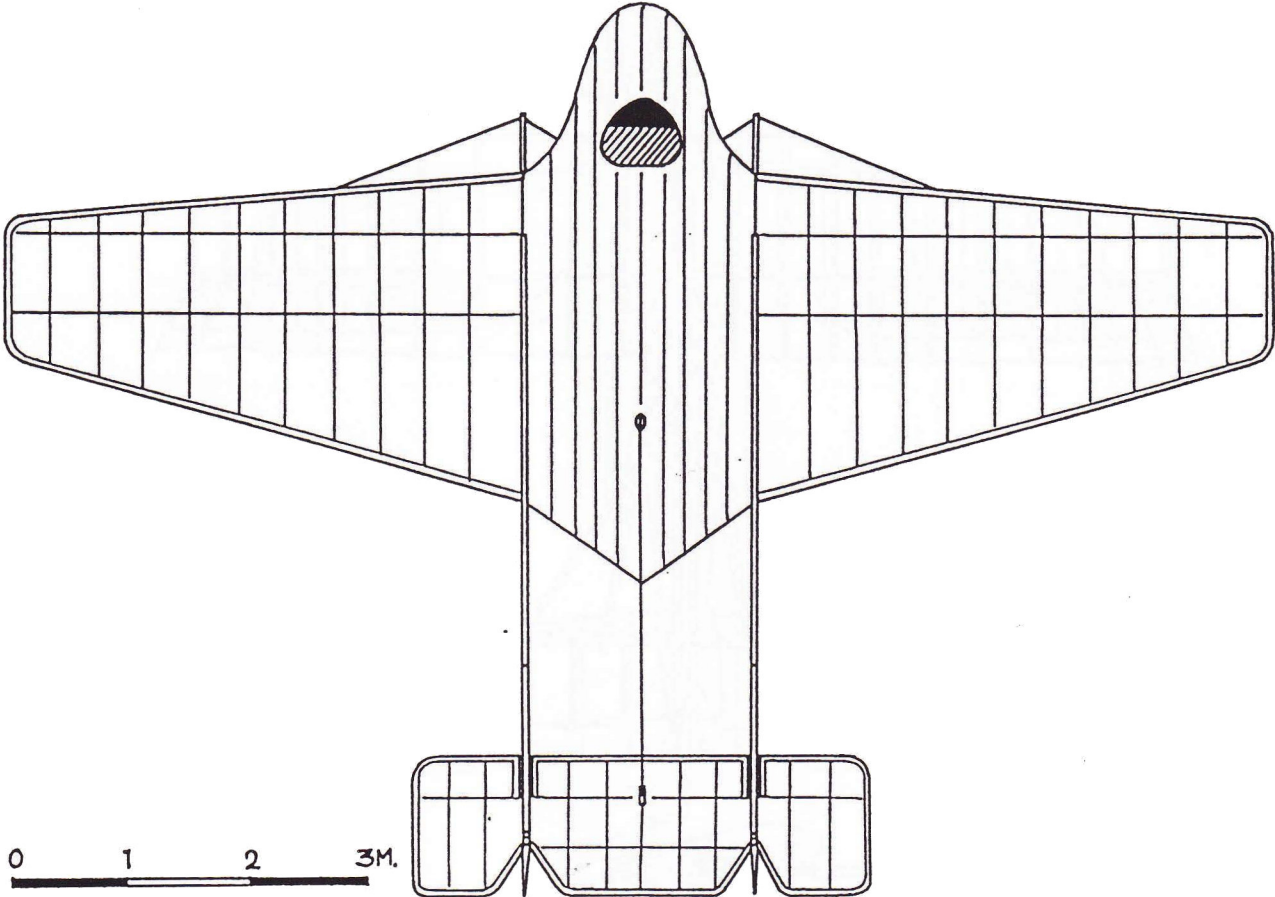
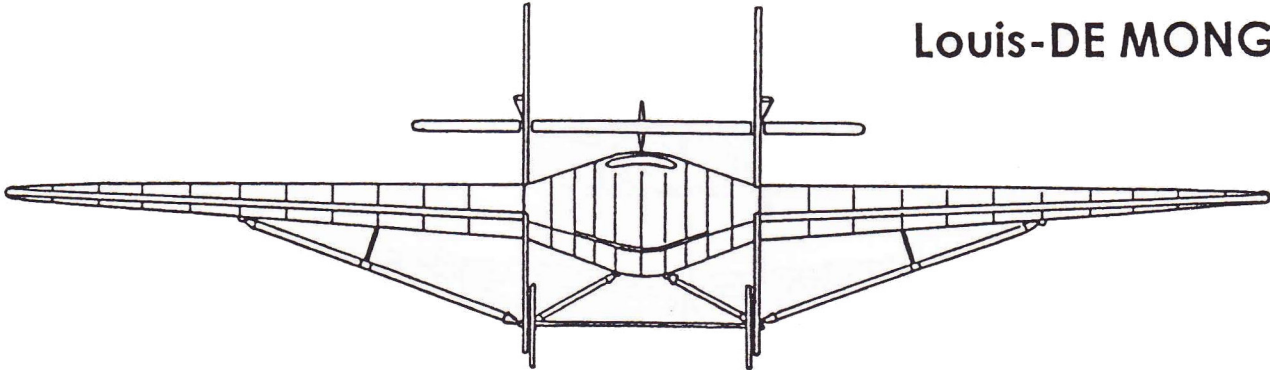

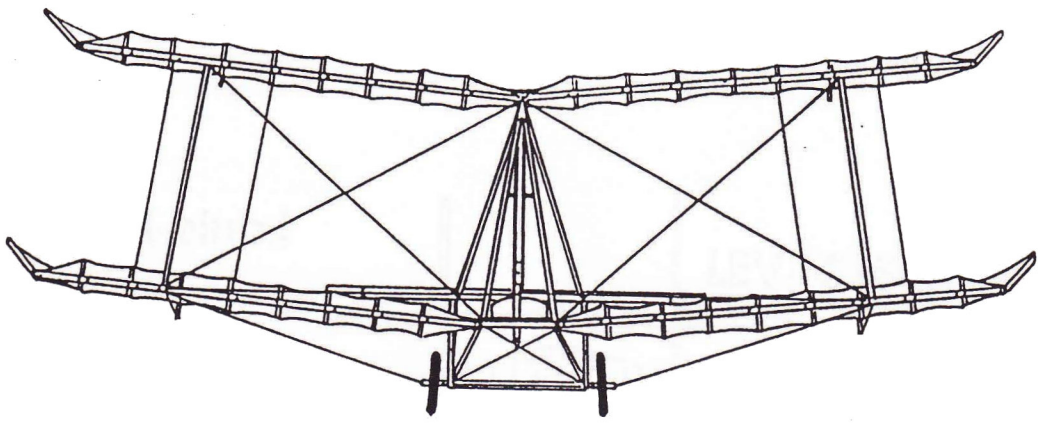

NESSLER N-2

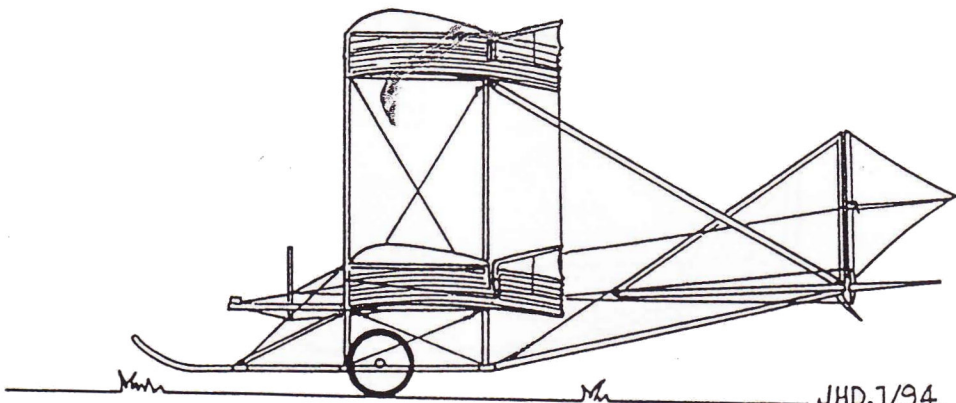
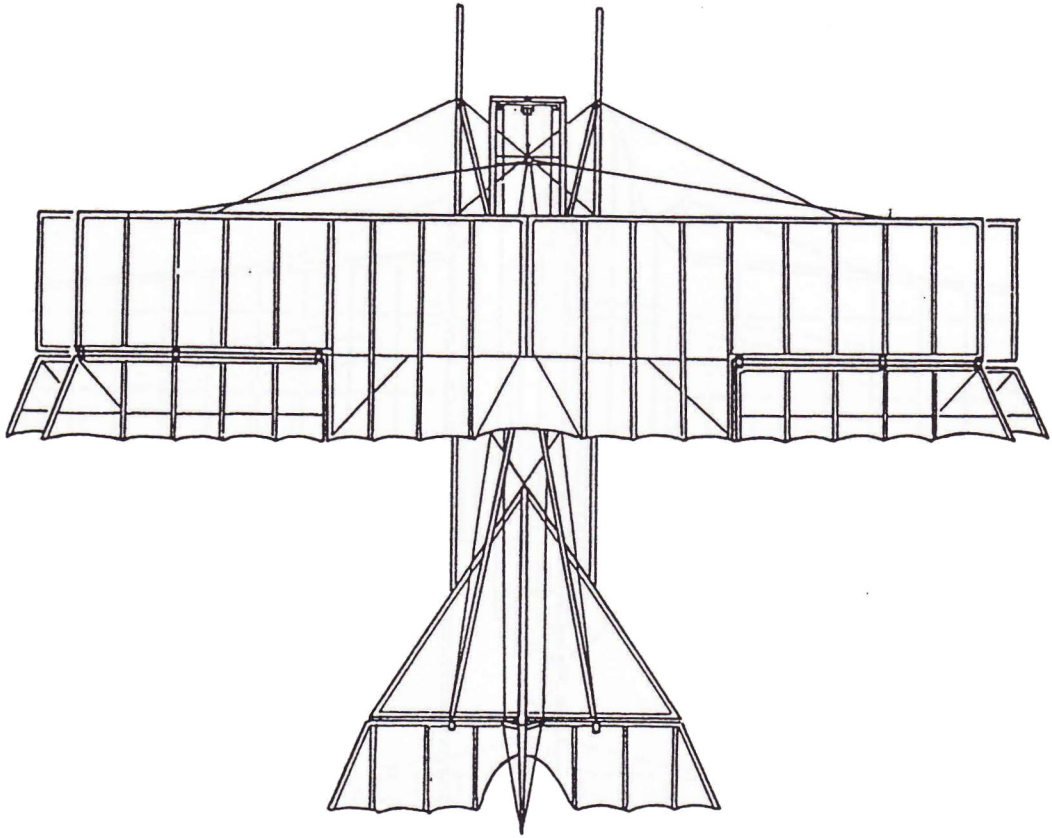

JHD.1/94.



# PEYRET Alérion

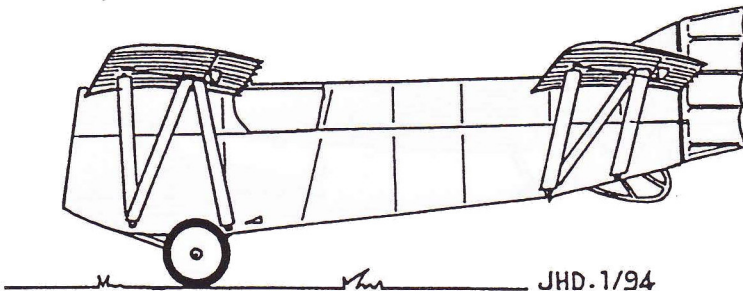
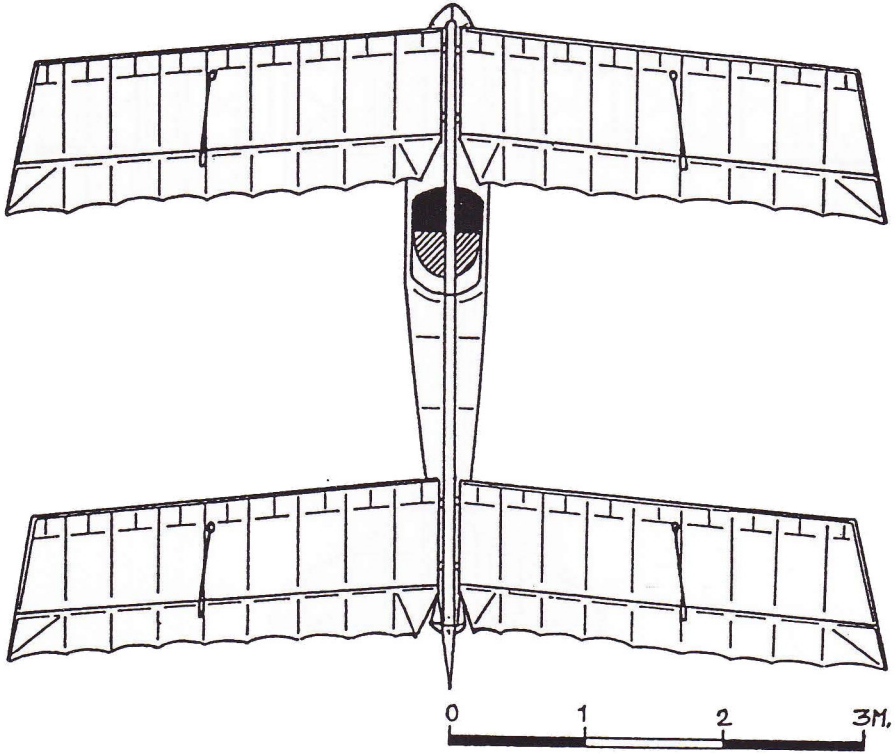
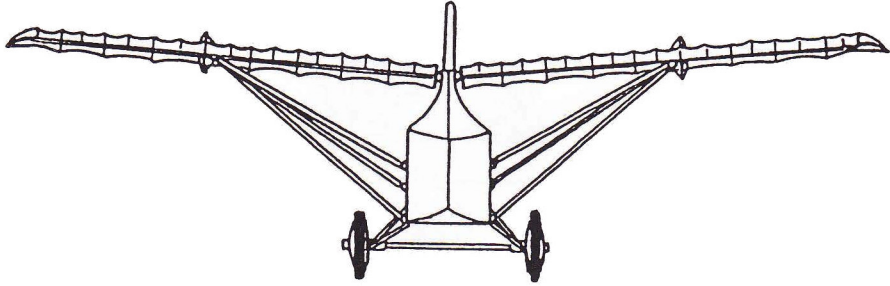



# POTEZ P-VIII

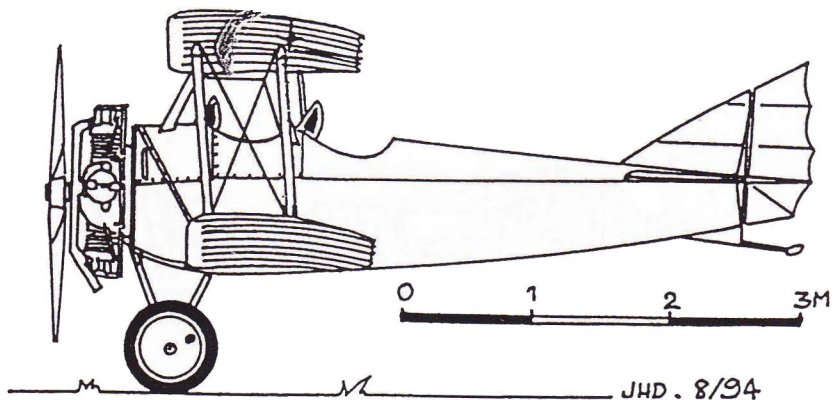
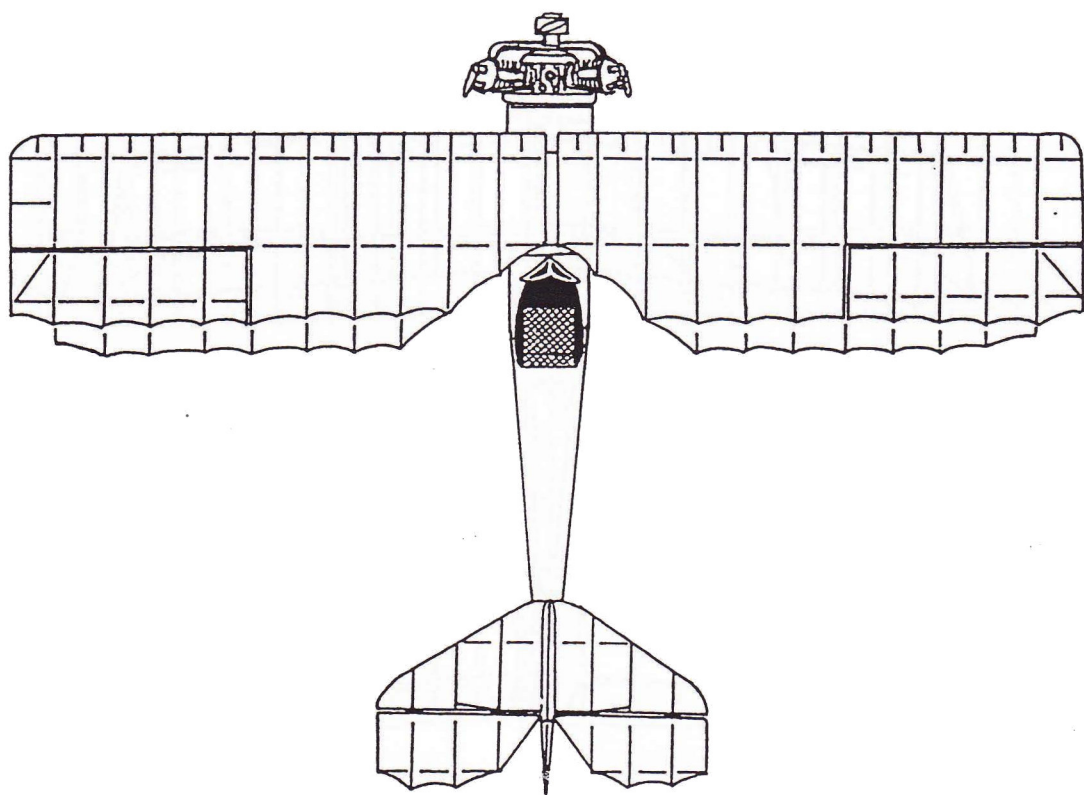
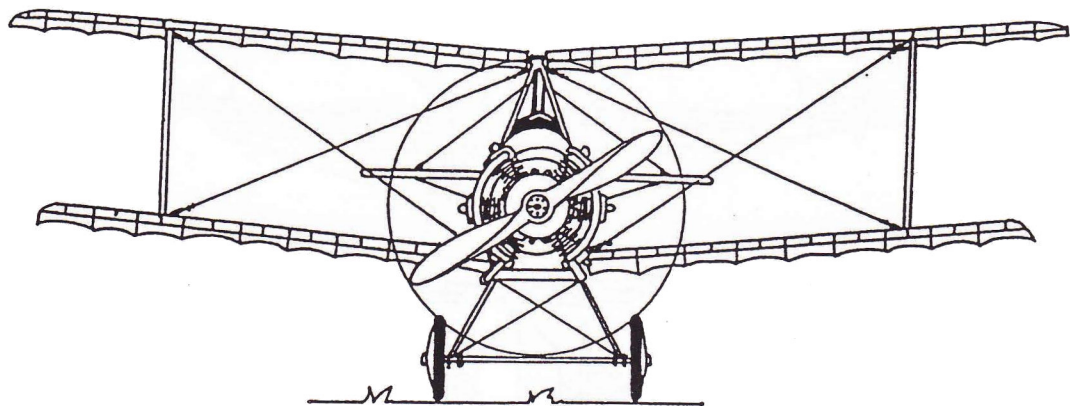

JHD. 8/94

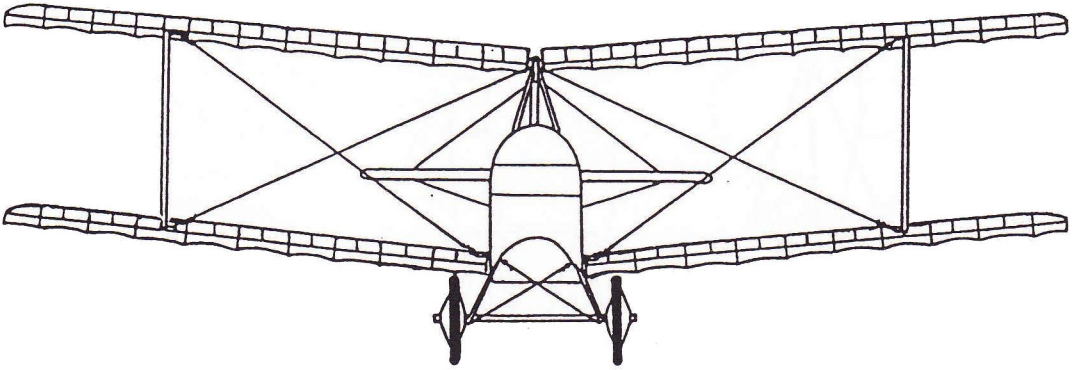

POTEZ P-VIII

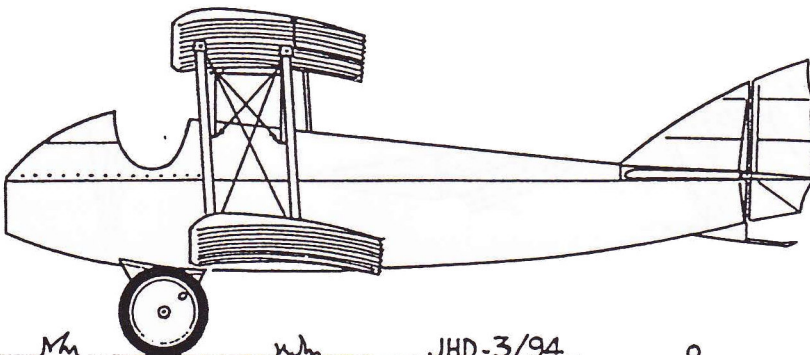
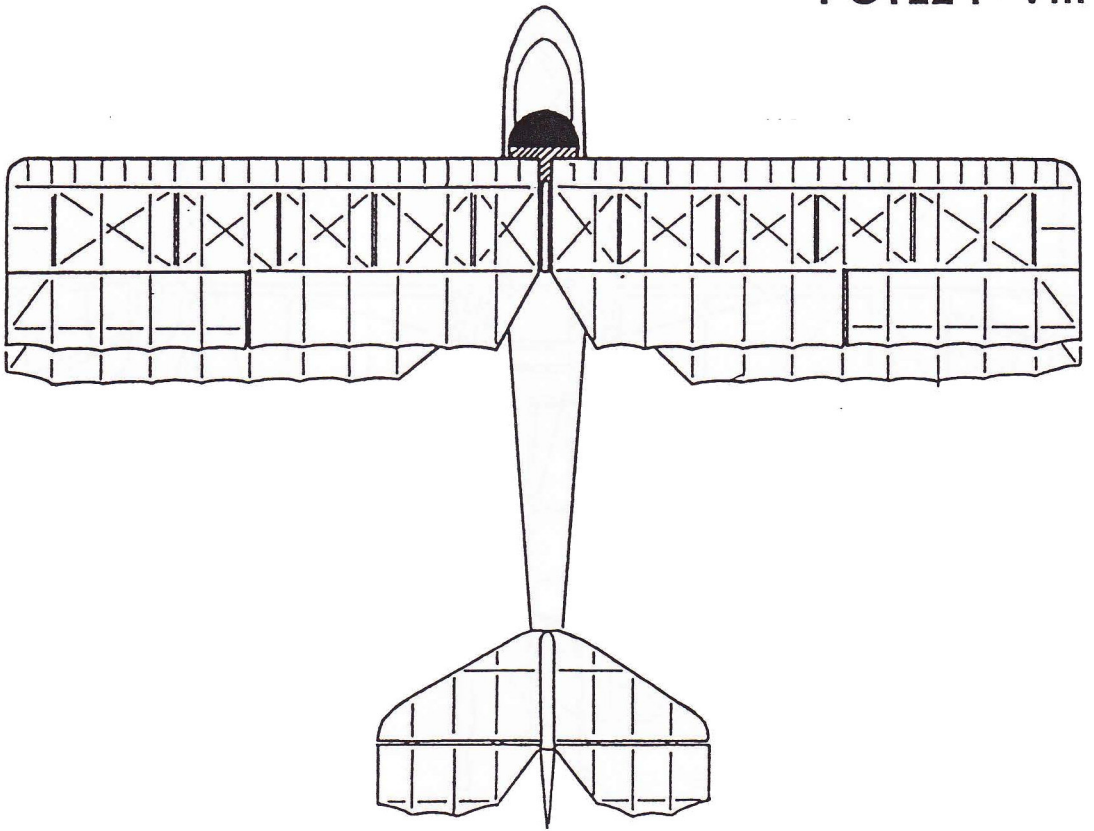

# ROLLE

